

SIDE PANEL

Installation / Maintenance Instructions

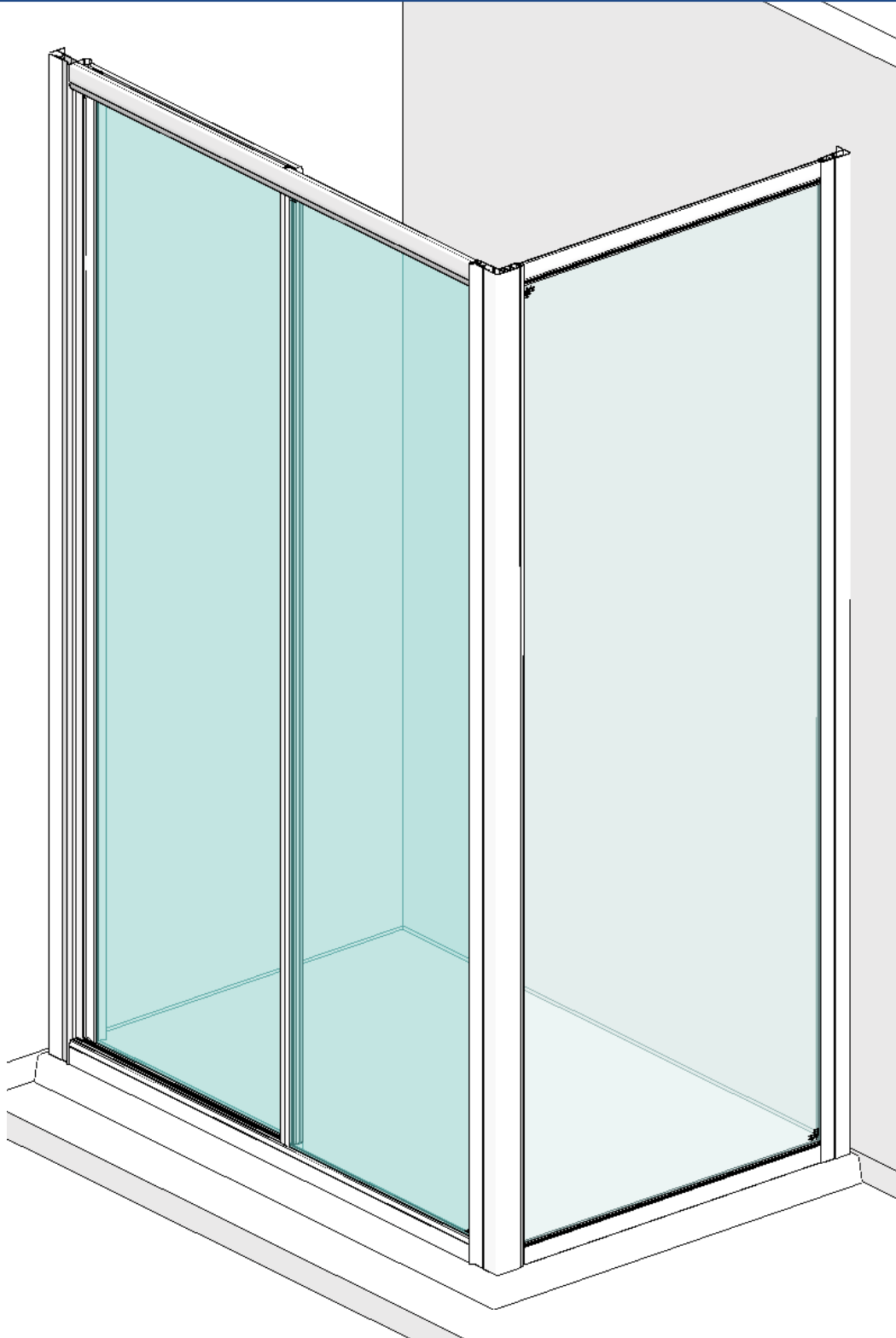

IMPORTANT NOTES :

Please Read Carefully & Retain these instructions for Future Reference.

1. For ease & safety we advise that two persons assemble this product.
2. Protect shower tray surfaces at all times.
3. Check for cables, pipes etc before drilling walls.
4. Ensure all surfaces are dry, clean & free of loose debris / dust.
5. Unpack goods with care (small parts can become lodged in packaging & inadvertently discarded). Check parts supplied against parts & fittings listed herein. Damaged parts / Omissions may be resolved by calling Lakes Bathrooms Helpline.
6. Whilst precautions are taken in manufacture, care must be taken when handling as rail ends may have sharp edges.
7. Before commencing, check :
 - a) shower tray is level & completely sealed to finished / tiled walls.
 - b) finished walls are sound & free of cracks loose tiles / grout.
8. AFTER INSTALLATION, DO NOT 'WET' ENCLOSURE FOR 48 HOURS TO ENSURE FULL CURE OF SILICONE SEALANT.

USE :

General Care & Maintenance.

Providing this product is installed & operated in accordance with these instructions, problems should not arise. However should maintenance be required it should be carried out by a competent person with reference to these instructions. Before any work is carried out the root cause of the problem must be identified. Lakes Bathrooms service engineers are available if necessary to consult / carry out remedial work. Call Lakes Bathrooms HELPLINE.

Cleaning.

(Every one to two weeks depending on local water {hardness} conditions).

All glass panels in this product have a hydrophobic coating aiding 'runoff' of water droplets, reducing the need for frequent cleaning. For best appearance / product life however, regular cleaning is recommended.

Use ONLY mild soap / detergent solutions to clean. Rinse with water, squeegee glass panels & wipe frames dry with a soft cloth. Under no circumstances should abrasive, caustic or scouring products be used. Cleaning products should have pH value 4 ~ 8.

DO NOT use 'spray & leave' type cleaning products.

Non compliance with these cleaning instructions may cause plated / painted finishes to deteriorate & could adversely affect safe operation of the enclosure.

Limescale ~ should a build up of limescale occur, remove using a 50:50 solution of white vinegar & water applied with a soft cloth & rinsed / dried thoroughly afterwards.

Daily Care.

To prevent the build up of limescale, do not allow water droplets to dry on glass or frames. After showering, rinse with water, remove droplets from glass with a squeegee & wipe frame with a soft cloth.

Customer Service.

Quality Guarantee : Lakes Bathrooms Ltd guarantee Shower Doors & Enclosures against any manufacturing or material defects for the lifetime of the product. We will resolve defects free of charge by repairing / replacing parts as we feel necessary. To be 'free of charge' service work must be carried out by Lakes Bathrooms or approved agents.

Not Covered by this Guarantee : Damage or defects that result from improper installation, improper use, or lack of maintenance (including limescale buildup). Damage or defects that result from repairs / modifications undertaken by unauthorized persons. This guarantee is in addition to statutory & other legal rights.

What to do if something goes wrong : Should the product not function correctly on initial use, firstly, contact the installer to check that unit installation & commissioning are in accordance with these instructions. Should this not resolve difficulties or should performance decline, consult 'Troubleshooting' section to see if simple home maintenance is needed. Alternatively our HELPLINE staff can assist, or if necessary arrange for a service engineer to visit.

Spares : We maintain extensive spare part stocks. Spares can be ordered / purchased from your retailer in the first instance. Parts will normally be dispatched within two working days from order placement. Pro Forma invoices will be sent for cheque payments.

SUPPLIED PARTS :

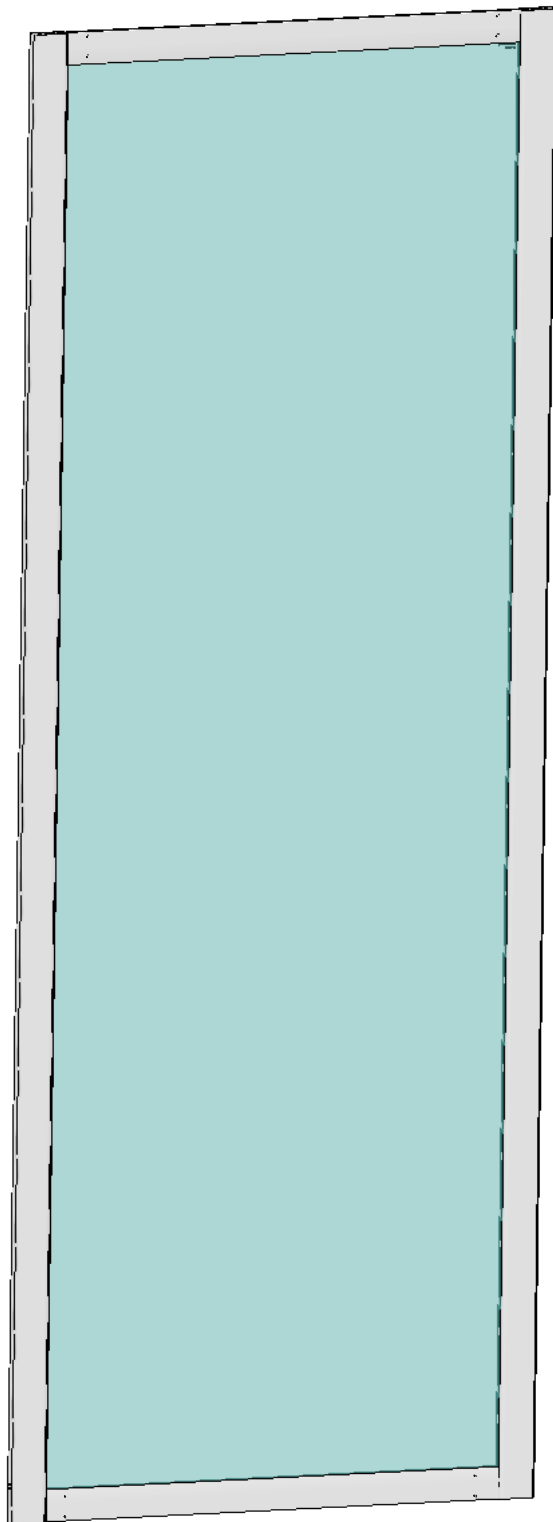

Panel Sub Assy (1x)
fig B



Corner Post
(1850mm x1)
fig B

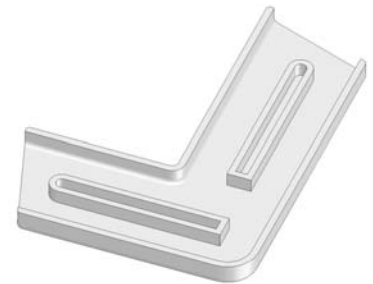

Top Cap (Corner Post)
(handed pair)
fig D

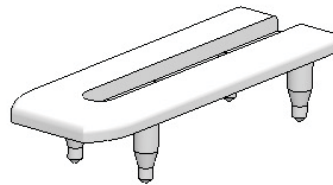

Top Cap (Vertical Rail)
(handed pair)
fig D



3.5 x 10 long self tapping
pan head screw (6x) fig C



Cup Washer (6x) fig A / C



Decorative Screw Cover
Cap (6x) fig C

Standard Size	Adjustment (A)
700mm	660 to 720mm
750mm	720 to 780mm
800mm	760 to 820mm
900mm	840 to 900mm
1000mm	940 to 1000mm

Tools Required

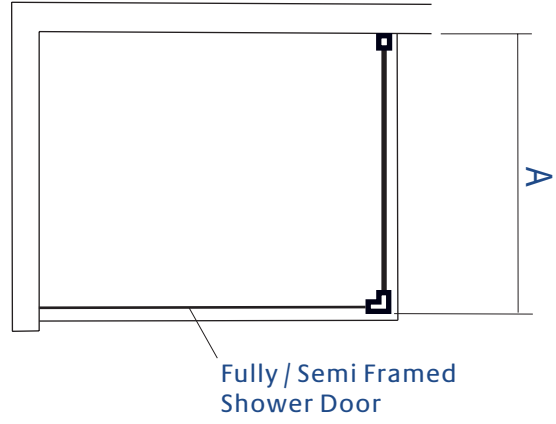
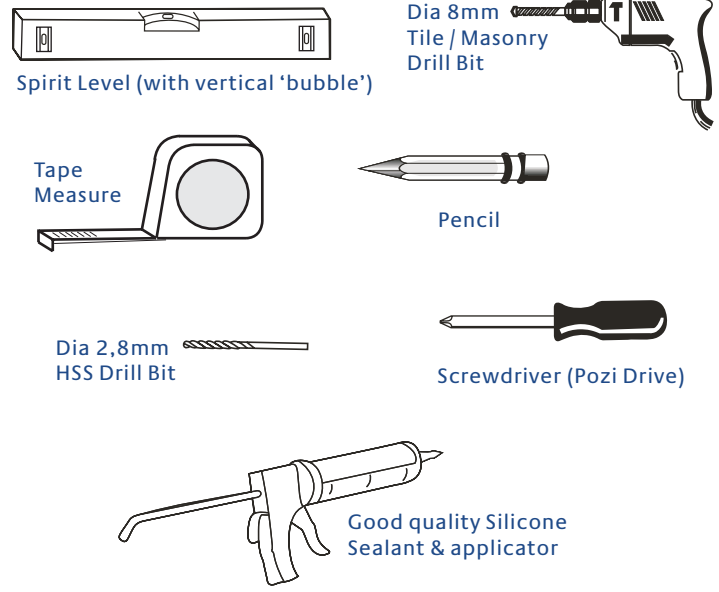

Lakes fully reversible Side Panel for use in conjunction with, & suitable for, fitting to left, right or both sides of Lakes fully or semi framed shower doors. Ensure tray is correctly levelled & that tray / wall (tile) joints are sealed & cured over entire length of tray sides (See Fig A) prior to fitting enclosure. **DO NOT SEAL TRAY EDGES UP TO A FITTED ENCLOSURE !**

A

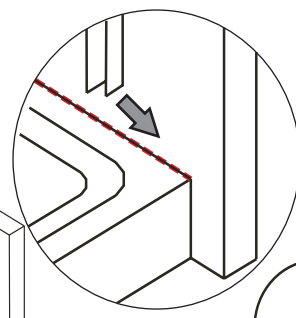
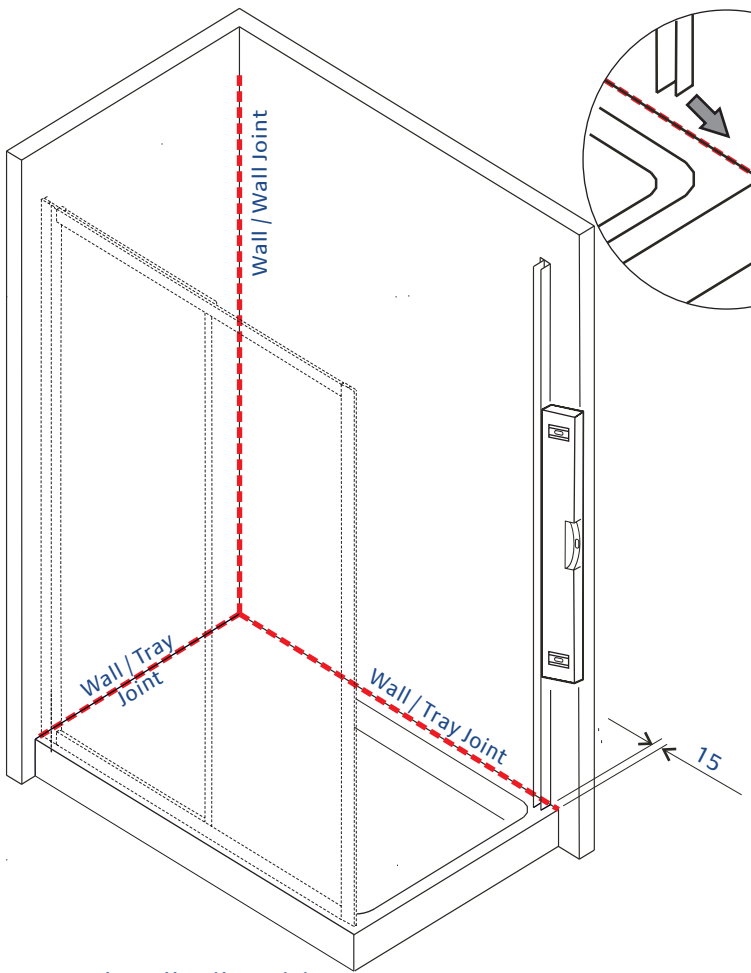

Ensure continuous silicone sealant bead before fitting wall rail

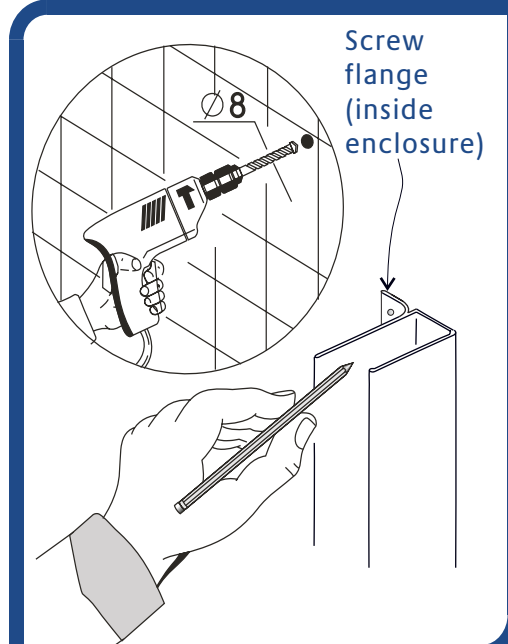
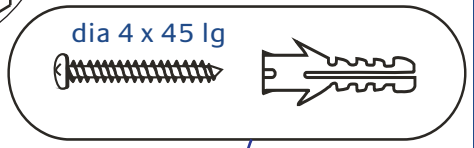

Measure & mark wall rail position.
Wall rail orientation (screw flange to inside of enclosure)
Mark fixing hole positions, drill, plug & affix wall rail.

Refer to respective shower door installation instructions for assembling door.
Door should be positioned loosely in its wall profile as shown ~ DO NOT drill & screw until final unit position has been determined (refer to fig C)

B Assemble Side Panel

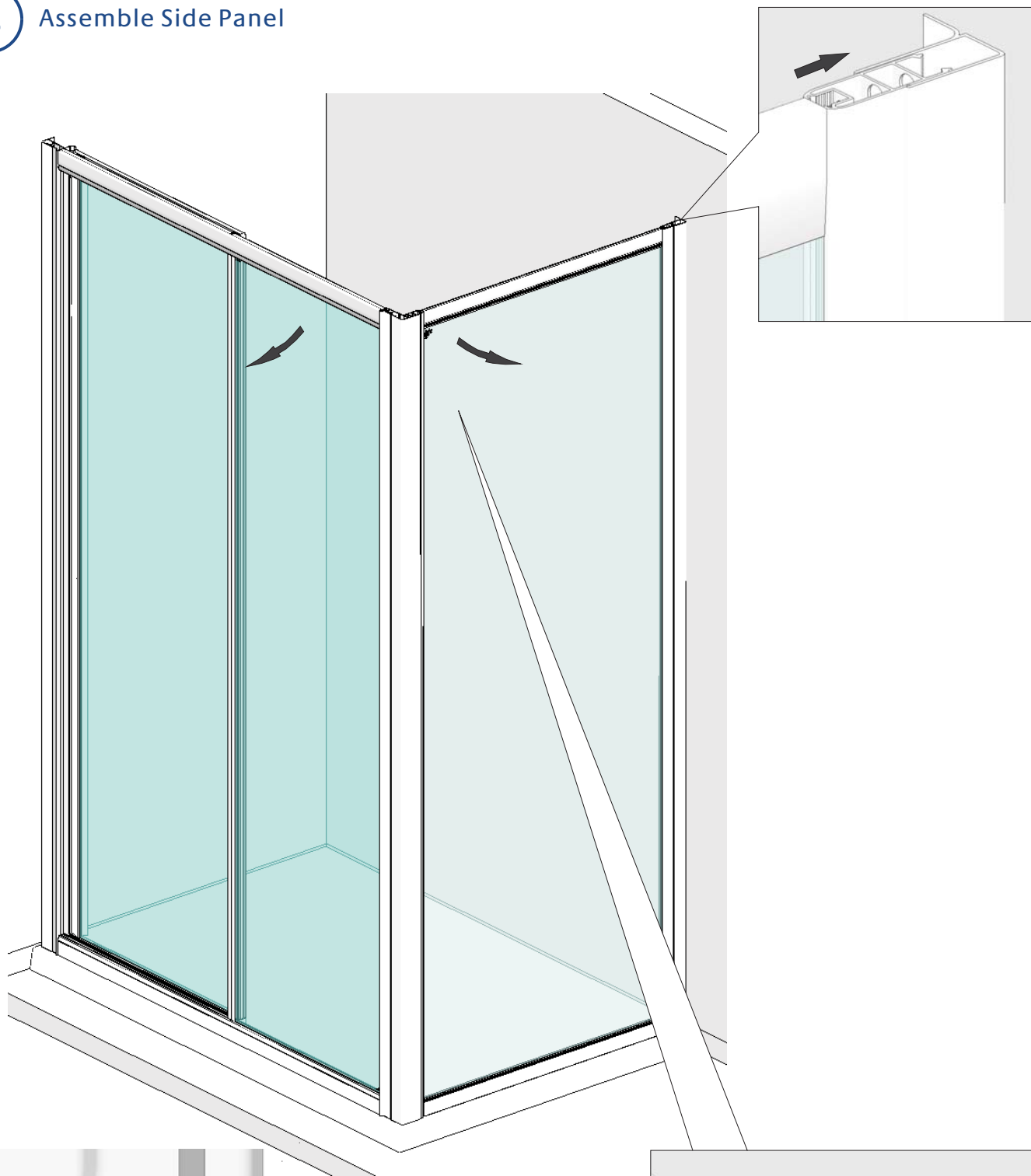

To ensure correct sizing, fit corner post such that side panel sits behind shower door as indicated. Door & Panel may be moved as shown to assist assembly.

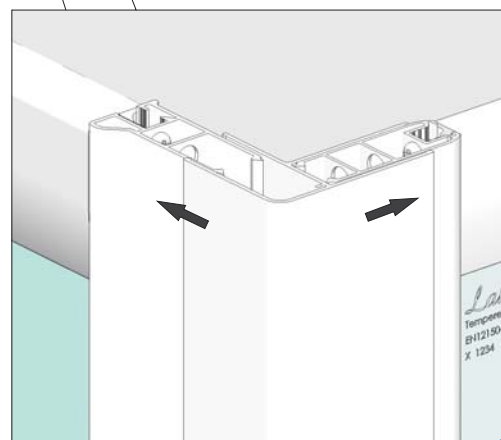

C

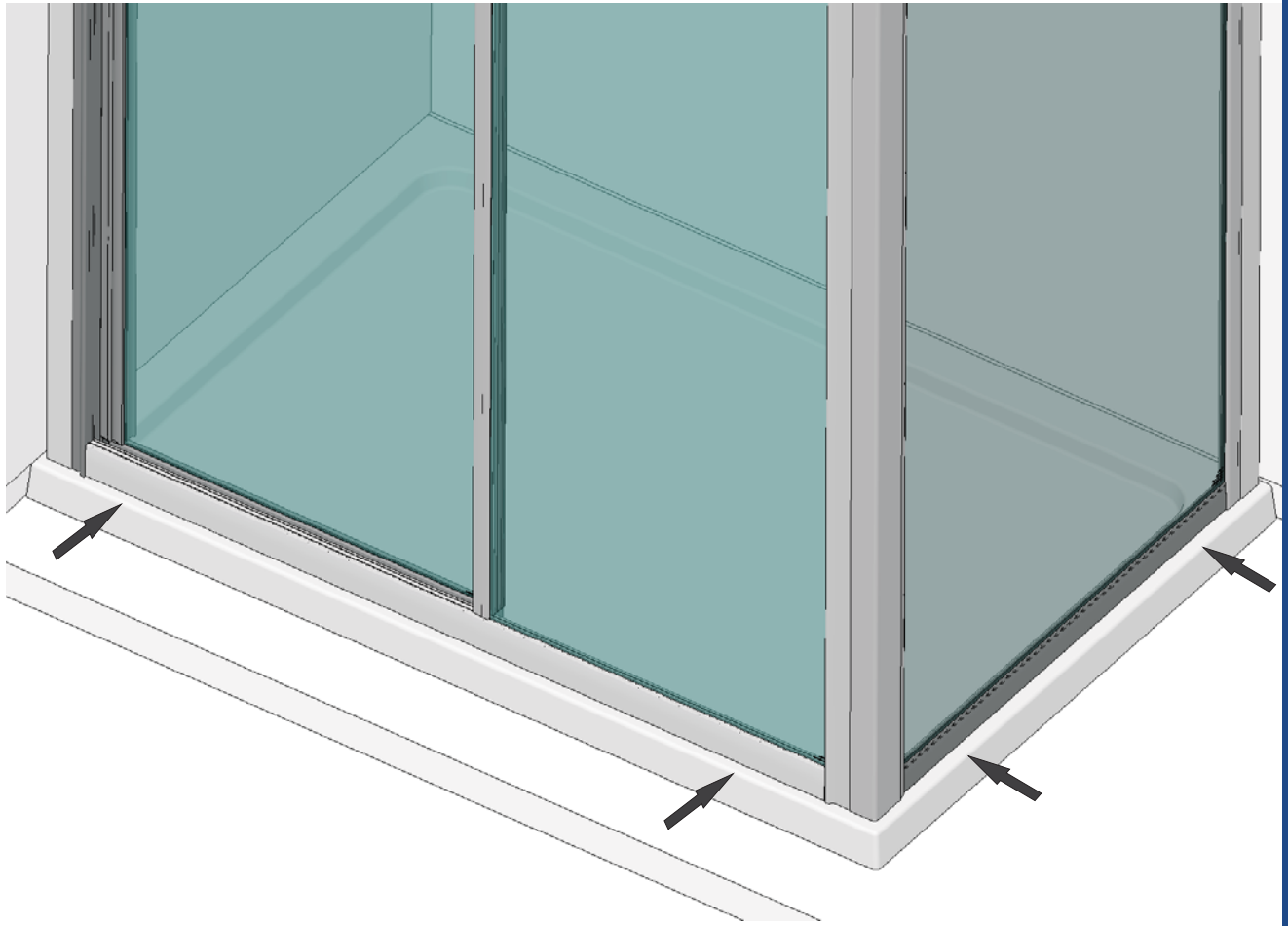

Adjust Door & Side Panel until desired position (sides parallel to tray edges) is achieved & enclosure is 'plumb'. Ensure that shower door functions correctly.
From inside enclosure, using wall rails & corner post holes as a guide, drill (dia 2,8mm) & screw enclosure together using 3,5 x 10 long pan head screws & washers (12 places in total), then fit decorative screw cover caps to all washers (including wall screws).



Shower Door Wall Rail

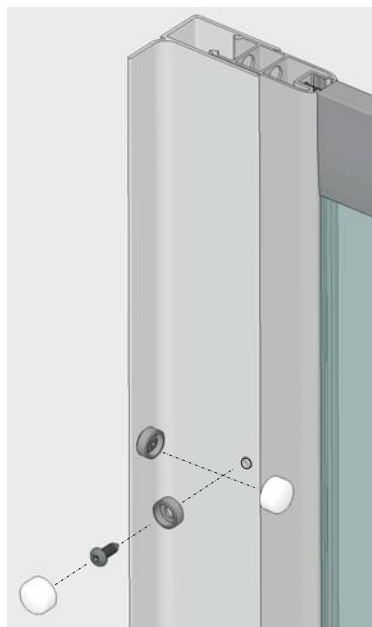

Side Panel Wall Rail

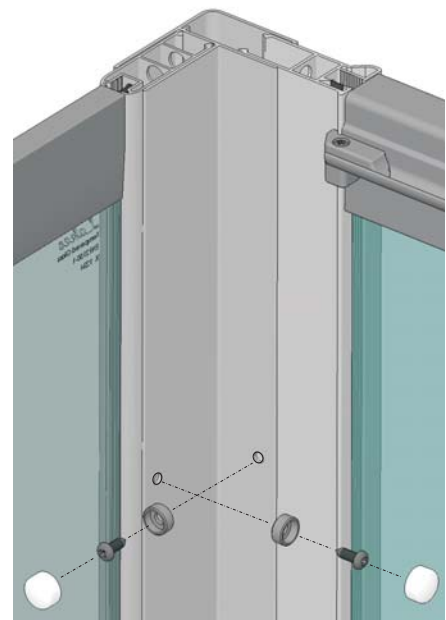

Corner Post

D

Where applicable fit profile top caps.

Note : Semi Frameless shower doors only are supplied with profile top caps. When using a fully framed shower door with a side panel it is suggested that the top caps are omitted for consistency of appearance.

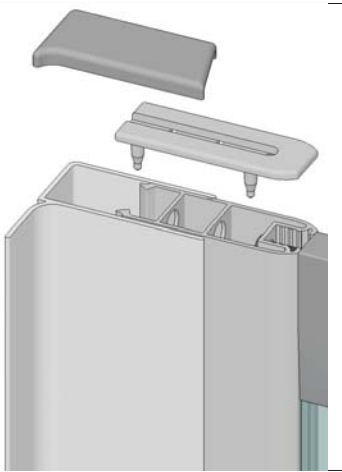

Side Panel / Wall Profile

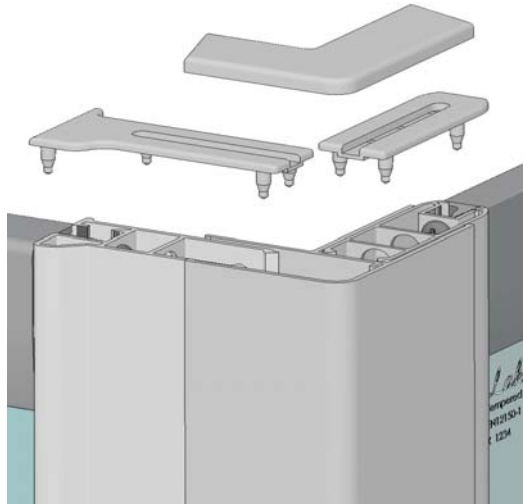

Corner Post

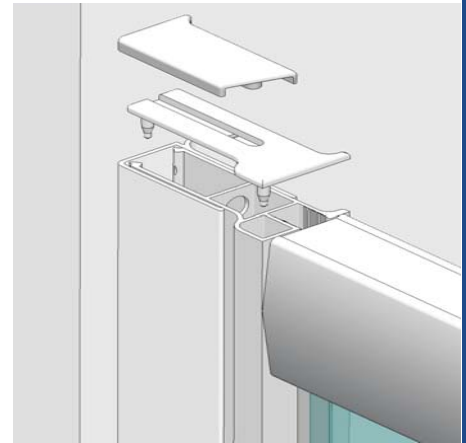

Door / Wall Profile

Select appropriate (hand) caps & press into profiles as shown, clear silicone sealant may be applied to retain, wipe off all excess with damp cloth.

E

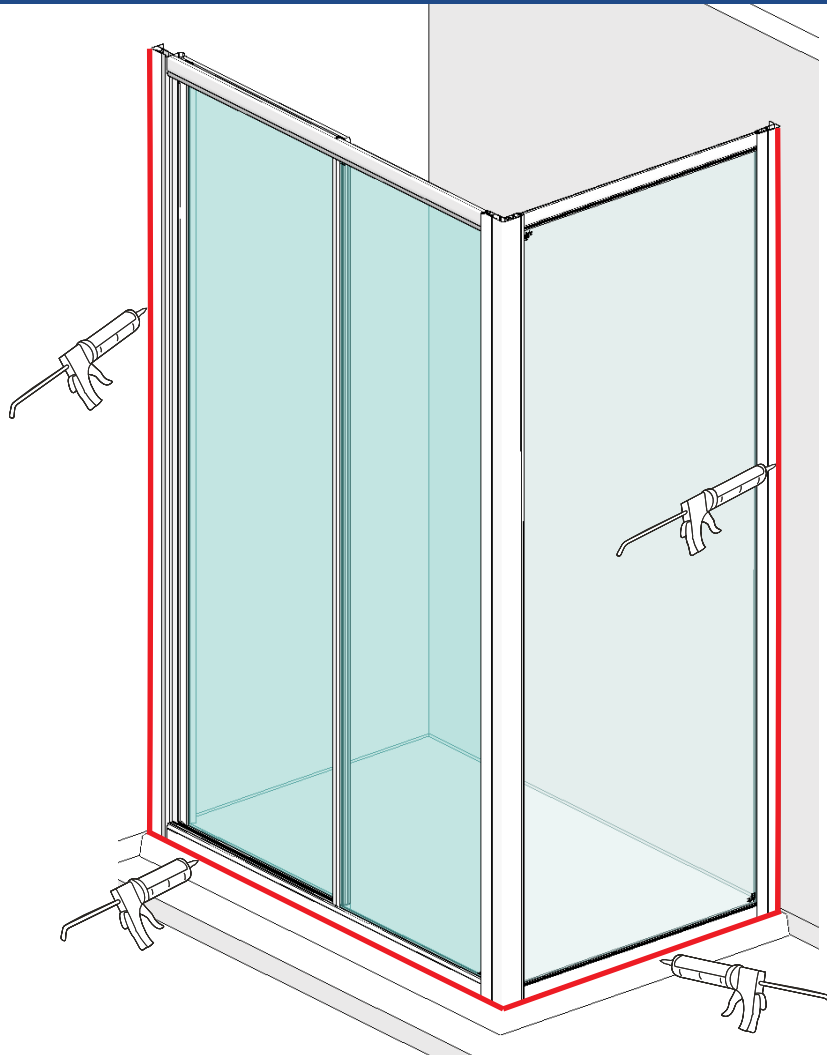

Use of good quality silicone sealant & cleaning / degreasing of all joint areas is recommended.

Apply continuous silicone sealant bead as indicated EXTERNALLY ONLY

BASIC TROUBLESHOOTING :

Refer to respective shower door installation instructions for troubleshooting information.

Leakage :

The sealing method described in these instructions relies on a continuous seal being applied between shower walls & tray before installing the enclosure (see fig A), it ensures a watertight seal around the perimeter of the enclosure to the shower walls & tray.

In the unlikely event of an enclosure leak, water will be visible on the outside of the enclosure itself, or around the perimeter silicone seal **ONLY**. Water / moisture appearing outside this area (ie at floor level) is normally due to incorrect tray installation.



Lakes Bathrooms Ltd
5800 Shannon Place
Tewkesbury Business Park
Tewkesbury
GL20 8SL

Service : England, Scotland, Wales
8.30am - 5pm Mon~Thurs
8.30am - 4.30pm Fri

Tel / HELPLINE : 01684 853870
Fax : 01684 276979
www.lakesbathrooms.co.uk
Email : admin@lakesbathrooms.co.uk

Service : Northern Ireland
Ian A Kernohan
Firtrees
Green Way Industrial Estate
Conlig
Northern Ireland
BT23 7SU

8.30am - 5pm Mon~Thurs
8.30am - 4.30pm Fri

Tel : 02891 270233
Fax : 02891 270597
Email : info@iakonline.com